

model kartonowy

1:25

MODELIK

Rok VI (XIII)

Nr 6/02

ISSN 1428-3840

BTR-80

ROSYJSKI TRANSPORTER OPANCERZONY



NOWA
EDYCJA !

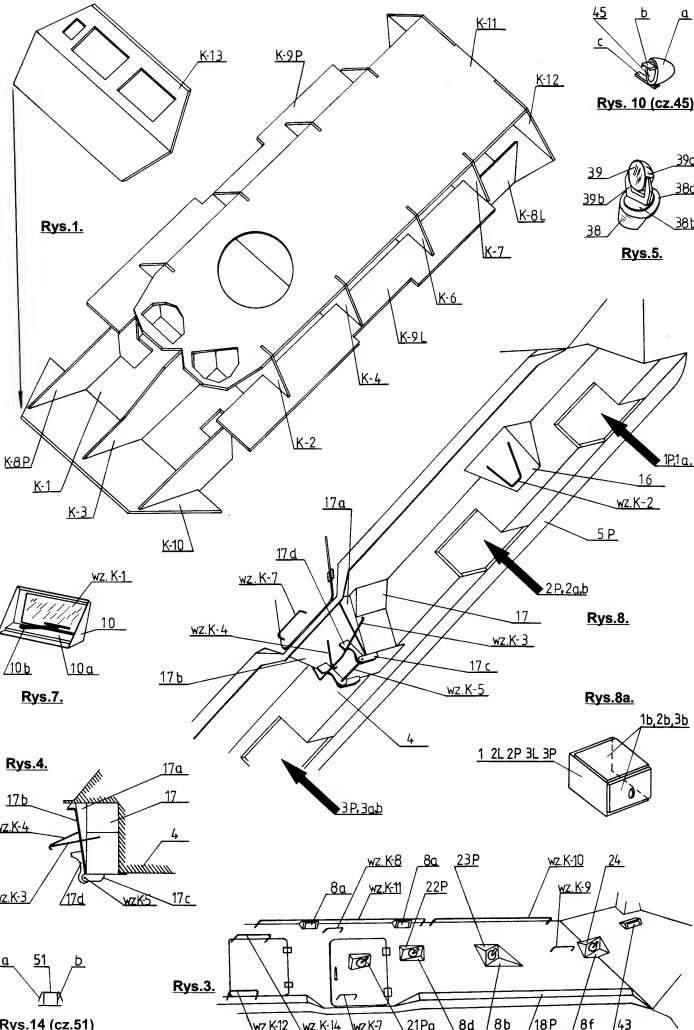

Rys. 1.

Rys. 10 (cz.45)

Rys. 5.

Rys. 7.

Rys. 8.

Rys. 8a.

Rys. 4.

Rys. 3.

Rys. 14 (cz. 51)

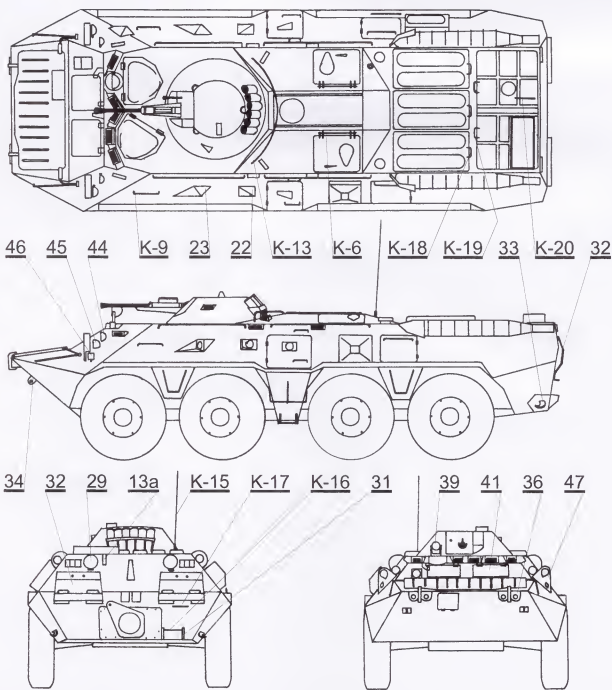
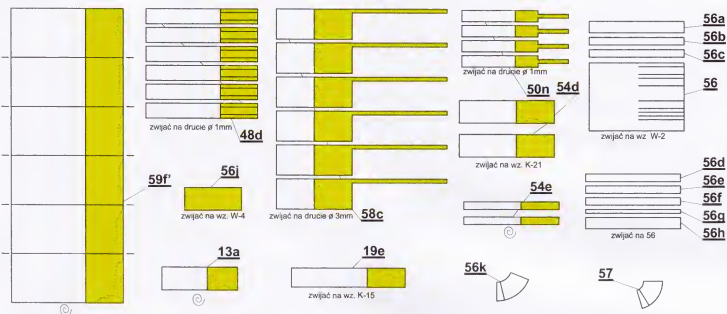

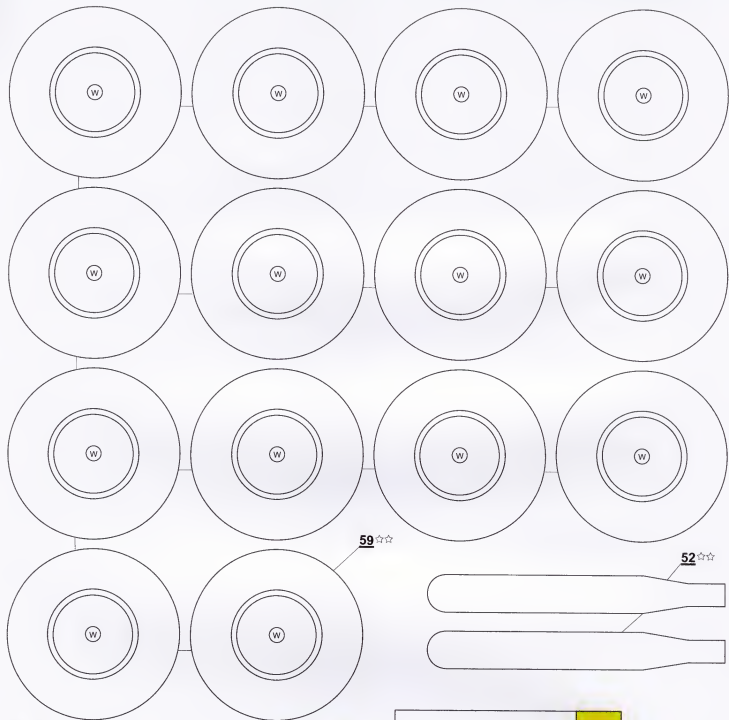

59 ☆☆☆

52 ☆☆☆

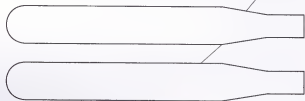

związać na wz. K-23

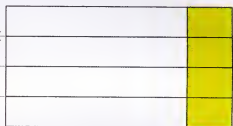
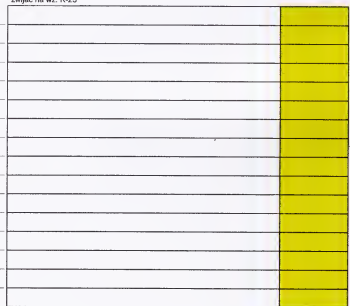

59u

59r



59s'

59w



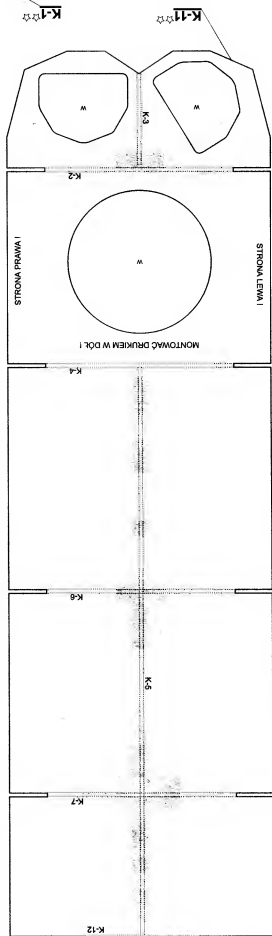
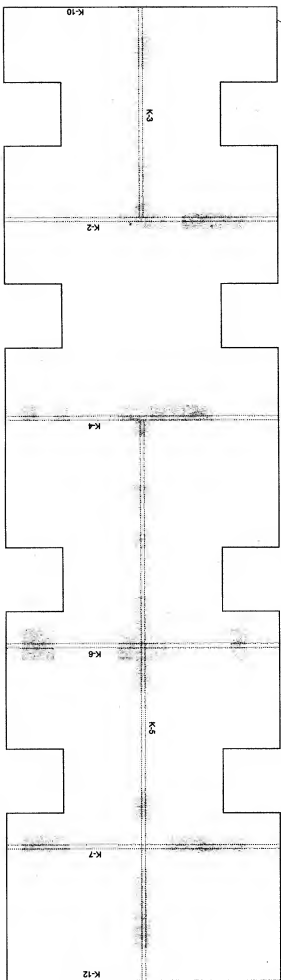
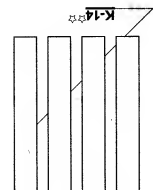
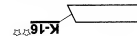
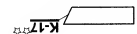
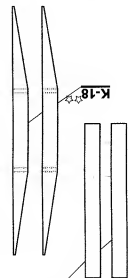
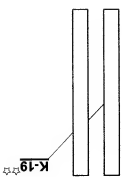



51 ☆

5P ☆

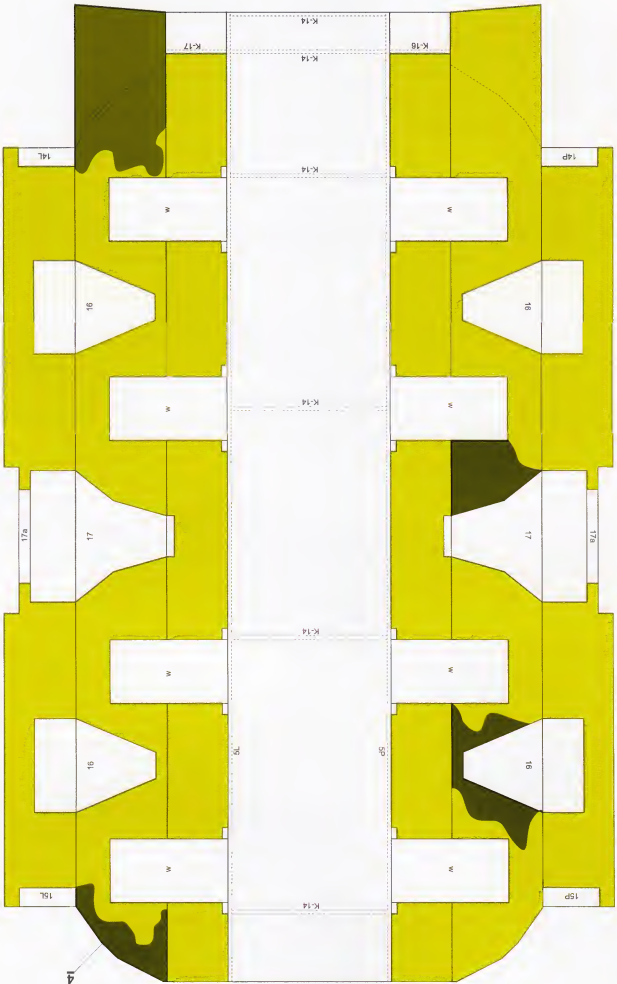

591

4

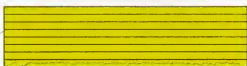

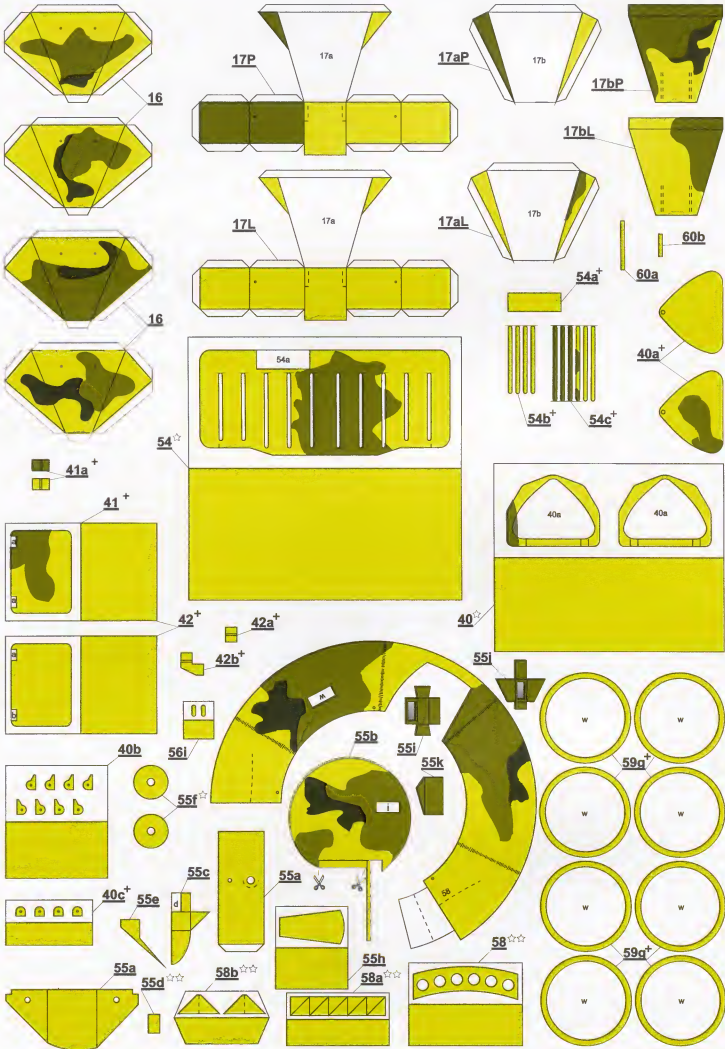

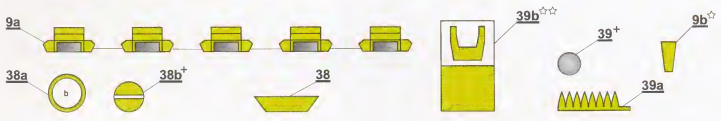
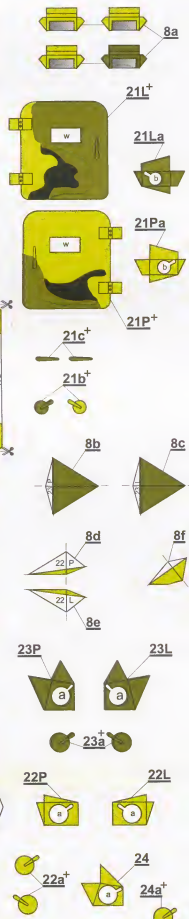
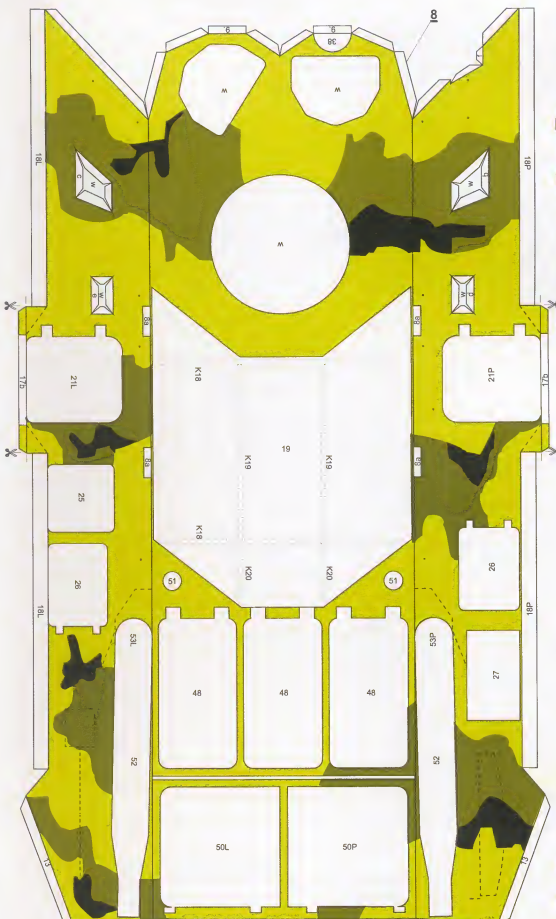

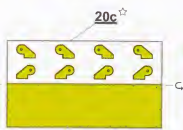
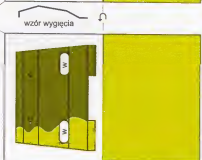
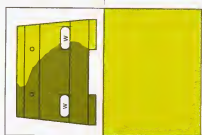
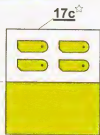
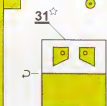
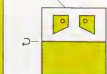
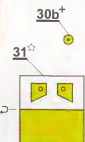
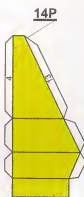
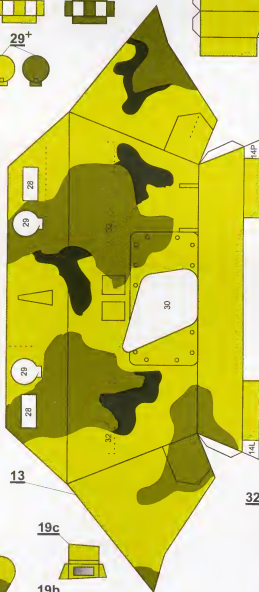
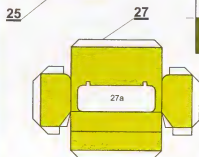
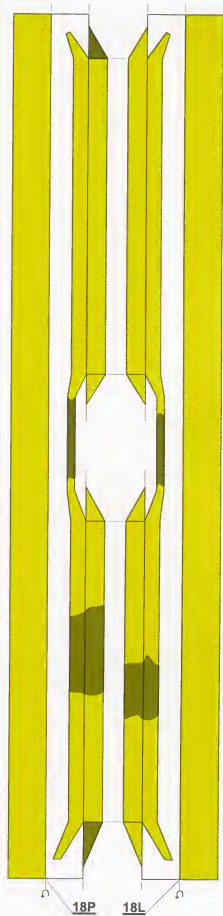

wzór wygęcia

13

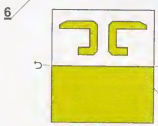
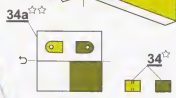
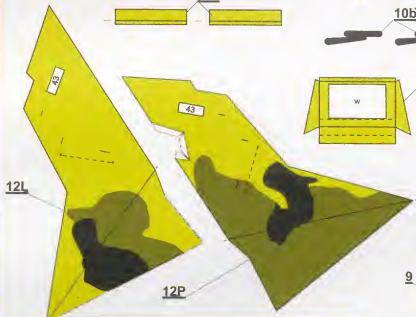
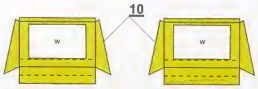
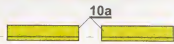
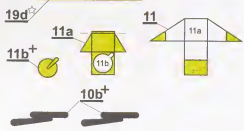
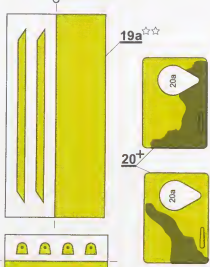
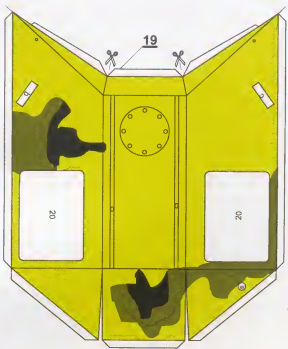
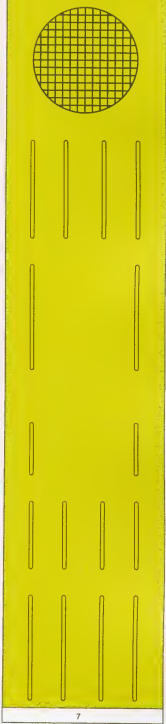

6

7

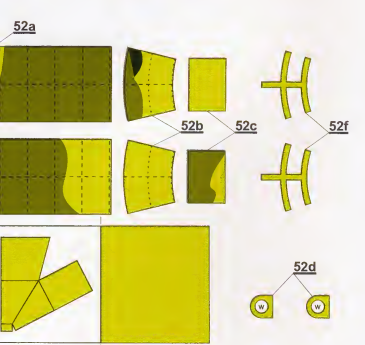
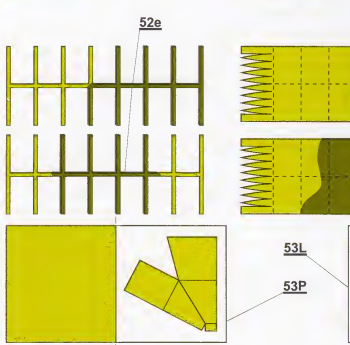
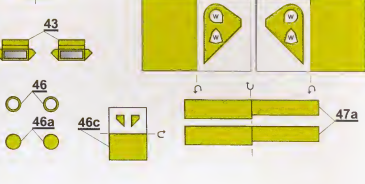
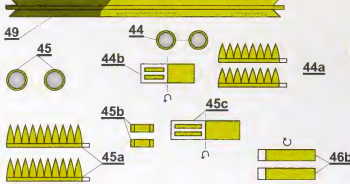
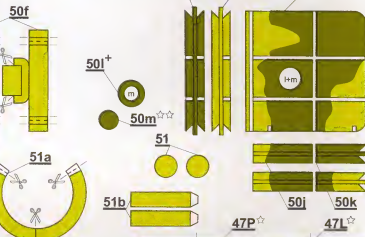
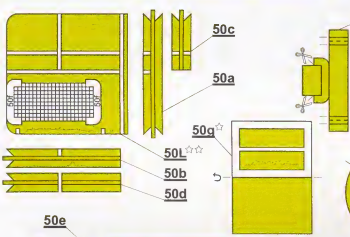
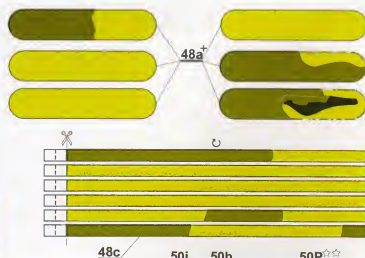
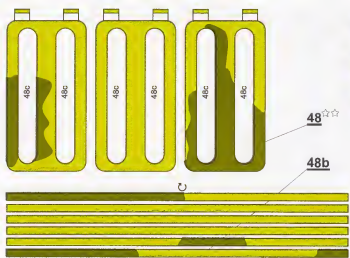

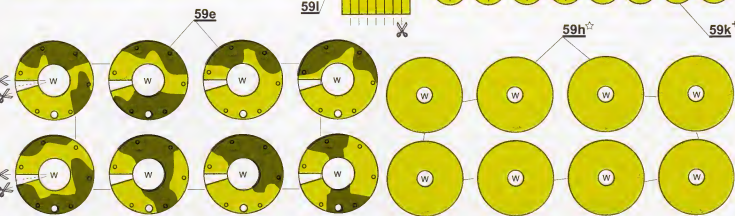
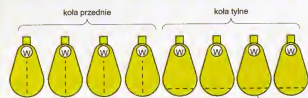
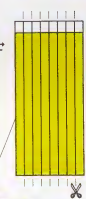
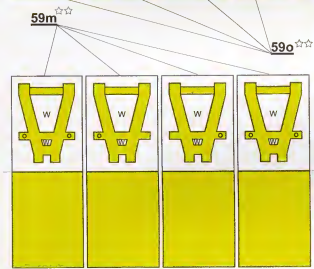
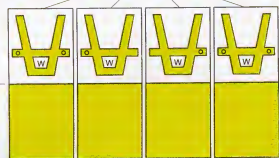
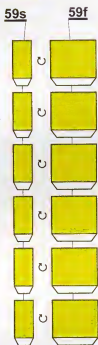
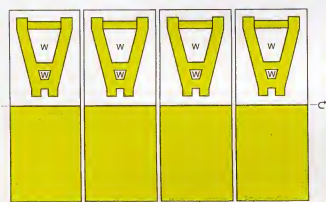
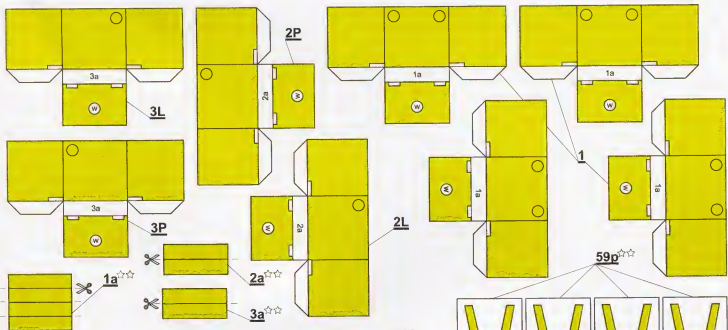

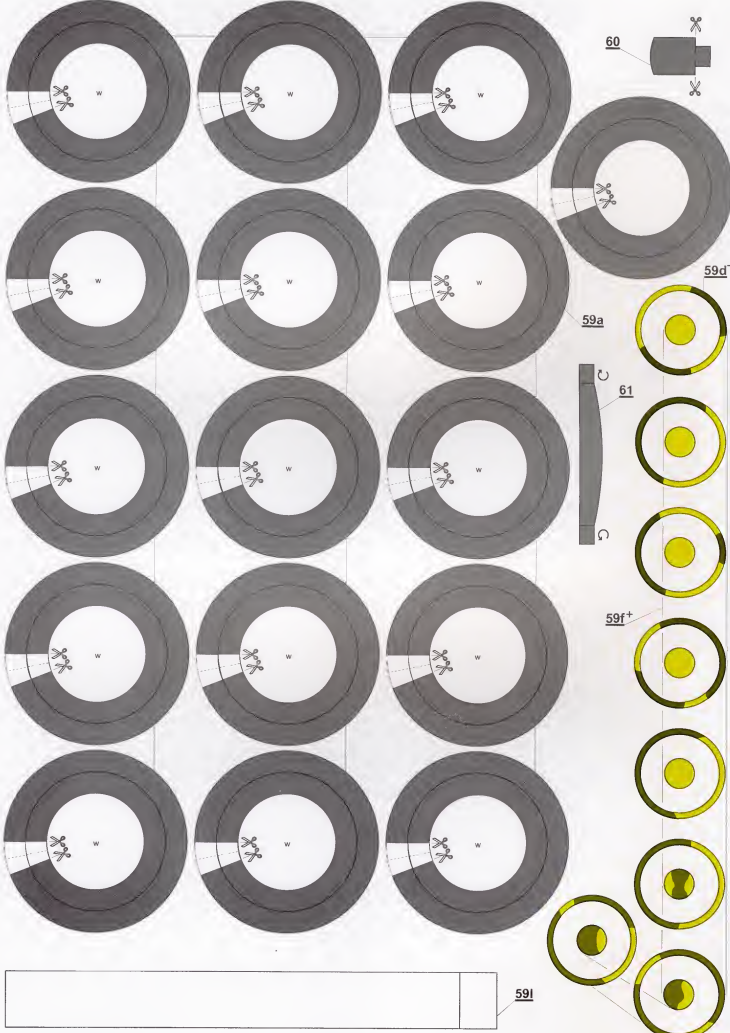

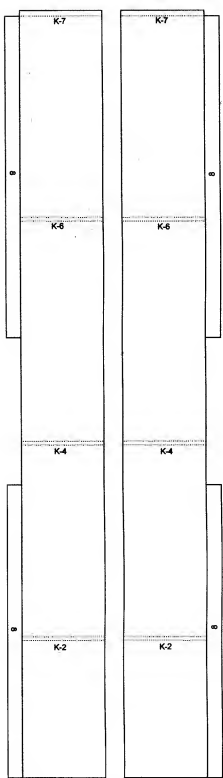

K-9P☆☆

K-9L☆☆

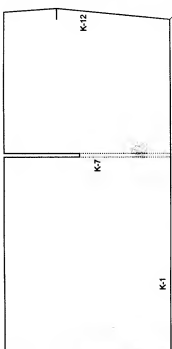
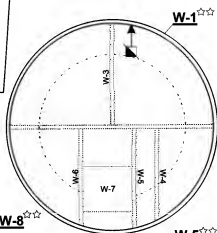
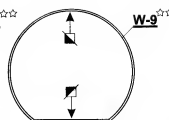
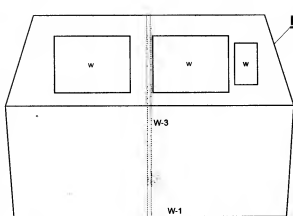

K-5☆☆

W-7☆☆



W-8☆☆

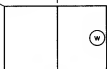
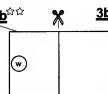
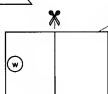
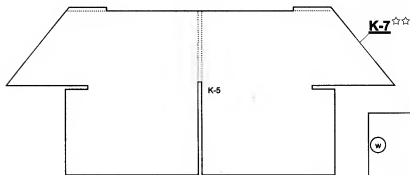
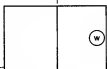
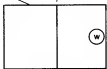
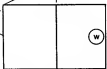
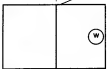
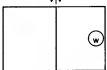
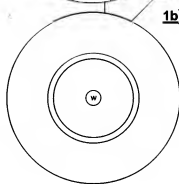
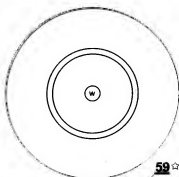
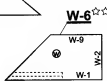
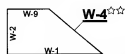
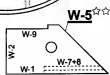
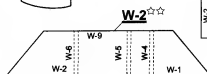

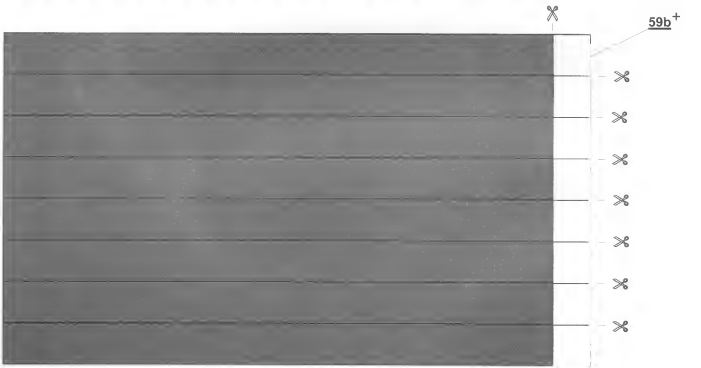
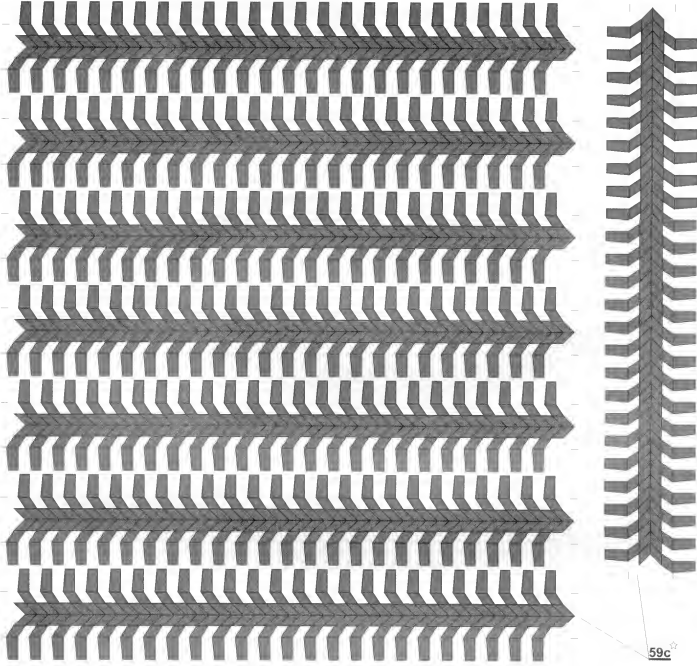

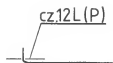

wz.K-22 ϕ 0,5mm 2szt.



wz.K-23 ϕ 2mm 8szt.



wz.K-24 ϕ 3mm 8szt.



wz.K-25 ϕ 4mm 8szt.



wz.K-26 ϕ 1,5mm 1szt.



wz.K-27 ϕ 1mm 2szt.



wz.W-1 ϕ 2mm 1szt.

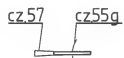

wz.W-3 ϕ 1mm 1szt.

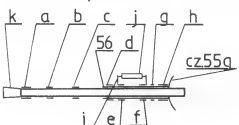

wz.W-2 ϕ 2mm 1szt.

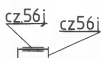

wz.W-4 ϕ 0,5mm 1szt.

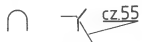

wz.W-5 ϕ 0,5mm 3szt.

WZORY / SZABLONY 1:1

celuloid

wz.K-1 2szt.

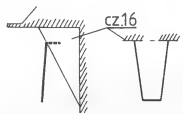

wz.K-2 ϕ 0,5mm 4szt.



wz.K-3 ϕ 0,5mm 2szt.

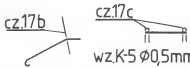

wz.K-4 ϕ 0,5mm 2szt.

wz.K-5 ϕ 0,5mm 2szt.



wz.K-6 ϕ 0,5mm 2szt.



wz.K-7 ϕ 0,5mm 2szt.



wz.K-8 ϕ 0,5mm 2szt.

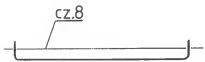

wz.K-10 ϕ 0,5mm 2szt.



wz.K-9 ϕ 0,5mm 2szt.

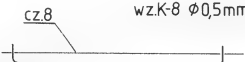

wz.K-11 ϕ 0,5mm 2szt.

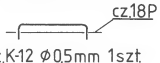

wz.K-12 ϕ 0,5mm 1szt.

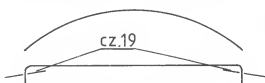

wz.K-13 ϕ 0,5mm 1szt.



wz.K-16 ϕ 0,5mm 1szt.



wz.K-20 ϕ 0,5mm 1szt.



wz.K-14 ϕ 0,5mm 2szt.



wz.K-18 ϕ 0,5mm 3szt.



wz.K-19 ϕ 0,5mm 2szt.



wz.K-15 ϕ 0,3mm 1szt.

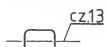

wz.K-17 ϕ 0,5mm 1szt.

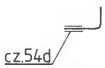

wz.K-21 ϕ 0,5mm 2szt.